

# USER MANUAL

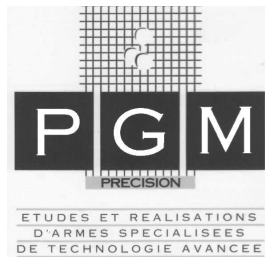

## ULTIMA RATIO

**INTERVENTION  
COMMANDO 1 & 2  
SUPRESSED**



Fixed and folding buttstock versions  
.308 W (7.62 x 51 mm NATO)  
and other calibers

Version 2.3

## CONTENTS

1. FOREWORD.....	3
2. GENERAL REMARKS .....	4
3. SAFETY INFORMATION .....	5
4. STORAGE AND TRANSPORT .....	7
4.1 Storage .....	7
4.2 Transport.....	7
5. GENERAL DESCRIPTION.....	8
5.1 Technical information.....	9
5.2 Accessories .....	12
6. USING THE RIFLE .....	13
6.1 Safety mechanism.....	13
6.2 Bolt .....	13
6.3 Magazine.....	15
6.4 Buttstock adjusting .....	16
6.5 Bipod.....	18
6.6 Trigger .....	18
6.7 Barrels.....	18
6.8 Muzzle brake and silencer .....	19
6.9 Scope mounts for picatinny rail.....	20
6.10 Transport case.....	21
7. MAINTENANCE.....	22
7.1 Breaking in a new barrel.....	22
7.2 Dismounting the weapon .....	22
7.3 Cleaning and lubrication .....	25

## 1. FOREWORD

PGM PRECISION thanks you for having chosen the model ULTIMA RATIO.

Highest care was taken for the development parts which constitute this weapon like to its assemblies.

This weapon has been tested by the Official Proof House for Firearms and Ammunitions of Saint-Etienne, then controlled and tested by us according to strict procedures. We hope that it will bring whole satisfaction to you.

☞ **Please read attentively and completely this manual before using your PGM ULTIMA RATIO. Do not hesitate to read it regularly.**

The information provided in this handbook, the photos and the images are not contractual. PGM PRECISION reserves itself the right to change specifications without notice.

To obtain further information, please contact your retailer or directly PGM PRECISION.

**PGM PRECISION  
BP 29  
74334 POISY CEDEX  
FRANCE**

Phone : +33 (0) 4 50 46 37 27  
Fax : +33 (0) 4 50 46 36 49  
Mail : [contact@pgmprecision.com](mailto:contact@pgmprecision.com)  
<http://www.pgmprecision.com>

## 2. GENERAL REMARKS

- ☞ Please respect the national laws which regulate the detention, the port, the transport and the use of firearms.
- ☞ A rifle, as any weapon can be dangerous. PGM PRECISION and its retailers decline any responsibility for the consequences resulting in whole or partly from :
  - a criminal intent or through negligence
  - a careless handling,
  - the use of defective, incorrect, damaged, unsafe ammunitions
  - an inadequate care of the rifle,
  - a resale in contradiction to legislation.
- ☞ Please keep this manual preciously. If you sell your weapon, please transmit this handbook to its purchaser.

### 3. SAFETY INFORMATION

- ☞ The weapon must be handled by complying with the safety requirements in force.
- ☞ Do not use this weapon under influence of alcohol or drug.
- ☞ Always check at first that the chamber is fully empty. Always handle the gun as if it was loaded. Keep the safety engaged until just before firing.
- ☞ Always check the barrel before firing to make sure it is free from obstruction.
- ☞ Never point any firearm at yourself or at any living being.
- ☞ Always shoot in direction from the target. Assure you that nobody is behind. If people are close to you, ensure you they stay behind.
- ☞ Never let handle your rifle by a person who is not informed about the details of safety and its handling.
- ☞ Never leave the weapon without supervision.
- ☞ Wear shooting glasses to protect your eyes from flying particles.
- ☞ Wear ear protectors to guard you against such damage. Unprotected, repeated exposure to gunfire can cause hearing damages.
- ☞ Never use “accelerator” ammunitions with muzzle brake or sound suppressor.
- ☞ If you detect off sound or light recoil when a round is fired, do not load another round into the chamber. Fully unload the rifle.
- ☞ If your weapon fails to fire, keep the muzzle pointed in a safe direction. Hold this position for a minimum of 30 seconds. Then remove the magazine. Carefully open the bolt in order to eject the round. The round should be disposed of in a way that it can't cause harm.
- ☞ Only use manufactured ammunitions of quality. The caliber is engraved on the bolt receiver and on the barrel.
- ☞ The use of reloaded or not standard ammunitions causes the immediate end of the guarantee. That can cause significant damage with the weapon and wound the user or other people.

- ☞ Only use ammunitions manufactured according to CIP norms.
- ☞ You can reload yourself your cartridges. Ensure however that you employ the load and the adapted type of powder and follow the recommendations of the handbook of recharging provided by the powder manufacturer or of the warheads you use.

## 4. STORAGE AND TRANSPORT

### 4.1 Storage

- ☞ Remove the bolt and be sure that the chamber is empty.
- ☞ Put the weapon in its case or in a carrying bag. Stock it in a strong cupboard.
- ☞ Ensure that none of these elements can be accessible by children or unauthorized people.
- ☞ Apply the laws in force concerning the storage of firearms.

### 4.2 Transport

- ☞ Always transport the weapon unloaded. Put it in a carrying case or in a soft bag. Ammunitions and bolt have to be separated from the weapon.
- ☞ Apply the laws in force concerning the transport of firearms.

## 5. GENERAL DESCRIPTION

**ULTIMA RATIO** is a unique sniper rifle system for the discriminating marksman.

This bolt action and manually operated weapon is composed of 3 principal elements :

- A rigid aircraft alloy framework with a bipod.
- A receiver with adjustable trigger assembly and the bolt.
- A match grade free floating barrel, with locking in the barrel.

All the barrels can be changed instantly, without adjustment.

The range ULTIMA RATIO includes 4 models according to the barrels (from top to bottom) :

- **Commando II** (designed for paratroopers and SAS)
- **Commando I**
- **Supressed** (designed for subsonic ammunitions)
- **Intervention**

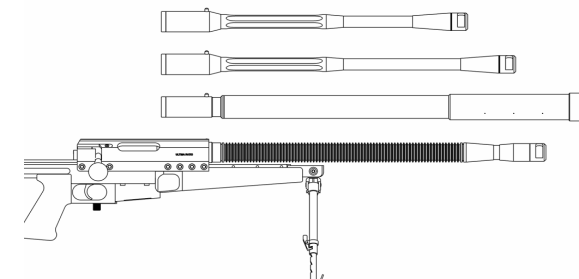

Different barrels

All those models are available in version 5 or 10 rounds, as well as in fixed or folding version.

## 5.1 Technical information

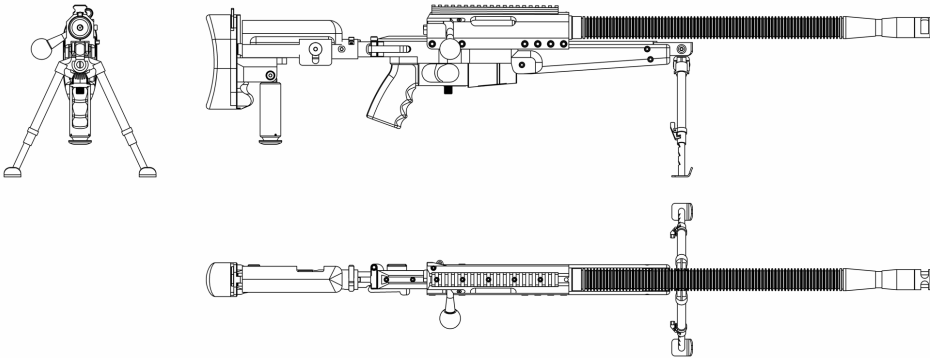

ULTIMA RATIO Intervention – 10 rounds – with folding buttstock

- Heavy match grade free floating barrel griped in the receiver,
- Barrel can be changed in approximately 30 seconds with a standard hexagon spanner and without adjustment
- Thermal dissipation accelerated by :
  - Barrel cooler with oil film (Intervention)
  - Fluted barrel (Commando I & II)
- Muzzle brake (except on silenced barrel)
- 5 rounds magazine (single row) or 10 rounds magazine (dual row) according to the model - steel
- Rigid aircraft alloy chassis
- Aircraft alloy receiver
- Black finished
- Bolt with 3 forward located lugs and overpressure vents
- Ultra fast travel firing pin
- Full adjustable double stage trigger
- Safety locks the trigger mechanism
- Folding bipod and retractable legs with adjustable banking brake

- Sling fixing points
- Adjustable cheek piece
- Ambidextrous handgrip
- Adjustable rigid folding or fixed buttstock
- Adjustable and folding butt spike
- Full interchangeability of pieces

	Intervention	Commando I	commando II	Supressed
Caliber	.308 W (7.62 x 51 mm NATO)			
Barrel length (mm)	600	550	470	400
Number of grooves (mm)	4	4	4	4
Twist (")	1 in 12			1 in 8
Range (m)	→ 600			→ 200
Trigger pull weight (kg)	1.2 to 1.8			
Length (retracted buttstock) (mm)	1105	1055	975	1173.5
Length (extended buttstock) (mm)	1158	1108	1028	1226.5
Length (folded buttstock) (mm)	873	823	743	941.5
Width (mm)	46			
Width (folded buttstock) (mm)	152			
Barrel axel / floor (mm)	188 / 256			
Magazine capacity	5 or 10			
Silencer length (mm)	x	290		610
Silencer weight (kg)	x	0.650		1.040
Weight (empty) (kg) <sup>(1)</sup>	7.390	6.260	6.120	7.080
Barrel weight (kg)	2.650	1.520	1.380	2.340
5 rounds magazine weight empty / full (kg)	0.115 / 0.240			
10 rounds magazine weight empty / full (kg)	0.165 / 0.420			
Pelican 1700 case dimensions (mm) <sup>(2)</sup>	911 x 353 x 133			
Pelican 1700 case weight (kg)	7.300			
Pelican 1750 case dimensions (mm) <sup>(3)</sup>	1286 x 343 x 127			
Pelican 1750 case weight (kg)	10.300			

All specifications subject to changes without notice

Specifications for .308 W calibre – 10 rounds -other calibers : contact us

<sup>(1)</sup> Complete weapon without scope – empty magazine

<sup>(2)</sup> only versions with folding buttstock (except silenced)

<sup>(3)</sup> all versions

## 5.2 Accessories

- Maintenance kit :
  - Extractor replacement kit
  - Ejector replacement kit
  - Firing pin replacement kit
  - Cleaning kit
  - Standard tool kit
  - Bolt dismounting tool
- Replacement barrel
- Silencer
- Sights
- Tactical slings
- Military bags
- Carrying plastic case
- Picatinny rail (flat, 20 MOA, 30 MOA or 1°)
- 500 mm long Picatinny Rail kit (20 MOA) + 2 lateral rails
- Scope mount
- Headspace gauges, extractor gauge, firing pin gauge
- Scope rings (Ø 25.4 mm, Ø 30 mm and Ø 34 mm)
- Special scope rings for night vision sights (Simrad KN, ZeissNSV80)
- Bore guide
- ...

## 6. USING THE RIFLE

### 6.1 Safety mechanism

- **Safety position (S) :**  
 Safety is ON, when the safety lever is in its rearmost position.
- **Firing position (F) :**  
 Safety is OFF, when the safety lever is pushed to its foremost position.

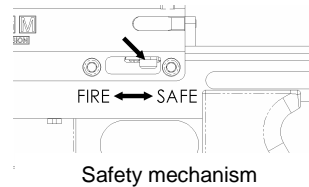

#### Caution :

- ☞ The safety lever can not be set at the position S (safe) as the firing pin is released.
- ☞ Remove your finger from the trigger while you're handling the safety.
- ☞ The safety lever must not stay between the 2 positions.

## 6.2 Bolt

### 6.2.1 Storage position

Using the releasing tool, place the bolt in position of storage for not wearing out the firing pin spring.

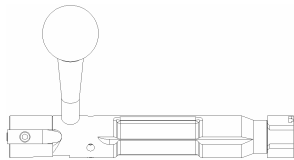

Storage position

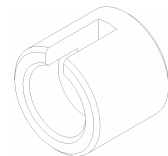

Bolt dismounting tool

### 6.2.2 Introduction

- ☞ **Ensure that the rifle is completely empty.**
- ☞ Version with fixed buttstock : fold the buttstock.
- ☞ Version with folding buttstock : remove the cheek piece.

- Remove the magazine.
- The firing pin extension must be in the insertion position. If the need arises, use the bolt dismounting tool

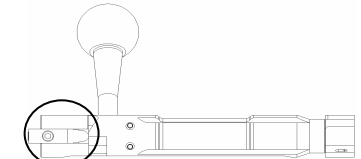

Booster in insertion position

- Introduce the bolt in the receiver.
- Close the bolt.
- Release the trigger.
- Open the bolt in rear position.

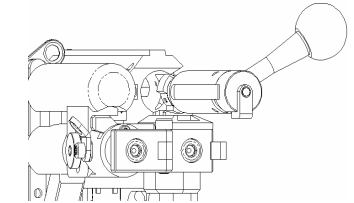

Bolt introduction

### 6.2.3 Removal of the bolt

- ☞ Version with fixed buttstock : fold the buttstock.
- ☞ Version with folding buttstock : remove the cheek piece.

- Push on the bolt catch and hold it in that position.
- Remove the bolt.

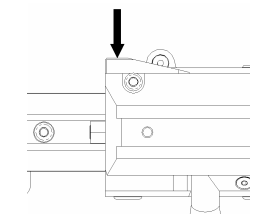

Bolt catch

### 6.2.4 Assembling and disassembling the bolt

**- Disassembling :**

Fit the rear part of the bolt into the dismantling tool. Hold the front part of the bolt in one hand. Turn the bolt in the clockwise direction until disassembling.

**- Assembling :**

- Align the firing pin extension key with the groove of the bolt.
- Push strongly the firing pin assembly using the releasing tool then turn ¼ in the anticlockwise direction.

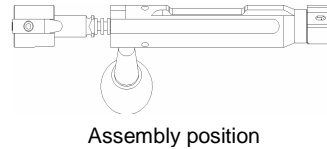

### 6.3 Magazine

#### 6.3.1 Unloading

- Pull the magazine catch rearwards and hold it in that position.
- Pull the magazine downwards.

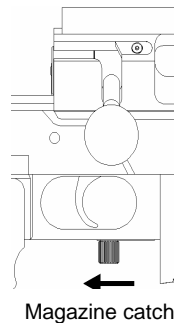

#### 6.3.2 Loading

- The magazine is loaded by pressing the cartridge head in front underneath of the holding lips and then pushing them into its rearmost position.
- Pull the magazine catch rearwards and hold it in that position
- Push the magazine up to the lock.

☞ With the 10 rounds magazine, this one must be gently removed before introducing the bolt.

### 6.4 Buttstock adjusting

☞ The buttstock, the cheek piece and the butt spike are fully adjustable.

#### 6.4.1 Fixed buttstock

**- Adjustment of the height :**

- Loosen the 2 screws with a 5 mm hexagonal spanner.
- Adjust the height of the cheek piece as desired.
- Tighten the 2 screws.

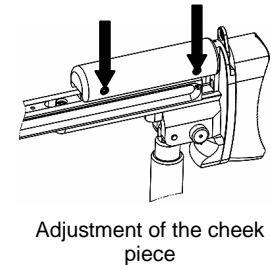

**- Adjustment of the length :**

- Remove the cheek piece by pulling it slightly forwards and then releasing its rear end from the buttstock.
- Loosen the 2 screws with a 5 mm hexagonal spanner.
- Adjust the length as desired.
- Tighten the 2 screws.
- Reinstall the cheek piece.

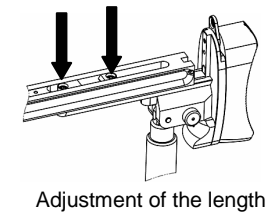

#### 6.4.2 Buttstock folding

**- Opening :**

- Press on the buttstock release knob.
- Turn the buttstock completely until it is locked into position.

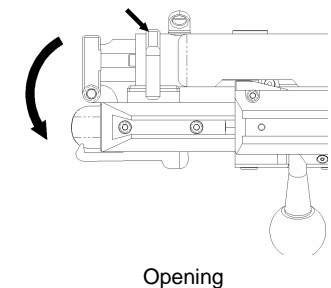

**Closing :**

- Press on the buttstock release lever.
- Turn the buttstock completely until it is locked into position.

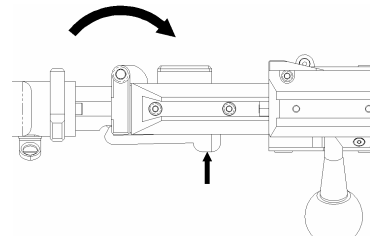

Closing

**Adjustment of the height :**

- Loosen the screw with a 5 mm hexagonal spanner.
- Change the height of the cheek piece as desired.
- Tighten the screw.

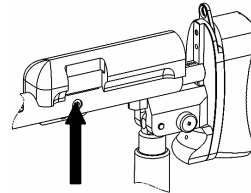

Adjustment of the height

**Adjustment of the length :**

- Loosen the screw with a 5 mm hexagonal spanner.
- Change the length as desired.
- Tighten the screw.

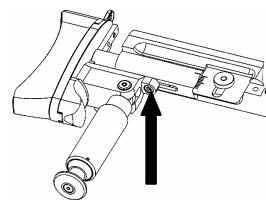

Adjustment of the length

**6.4.3 Butt spike**

The butt spike has 3 positions (0°, 45° and 90°).

- Push the unlocking and position the ground spike as desired and release the button.
- Turn the butt spike for precise adjusting.

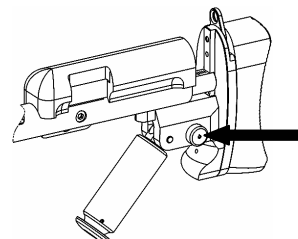

Adjustment of the butt spike

**6.5 Bipod**

**6.5.1 Using and setting**

- To unfold the bipod, squeeze its legs together and then pull them downwards.
- Length of the legs can be changed by pressing the catch and by pulling down or pressing the leg as far as needed.

**6.5.2 Adjustment of banking brake**

- Remove the front hand grip.
- Set the pressure with a 10 mm spanner as desired.

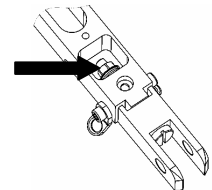

Adjustment of banking brake

**6.6 Trigger**

The trigger is adjustable for pull weight by an armorer.

**6.7 Barrels**

Before any intervention, ensure that the weapon is fully unloaded.

**6.7.1 Removal of the barrel**

- Remove the magazine and the bolt.
- Using a 5 mm hexagonal spanner, only loosen the 4 screws on the right of the weapon. Don't loosen more than necessary.

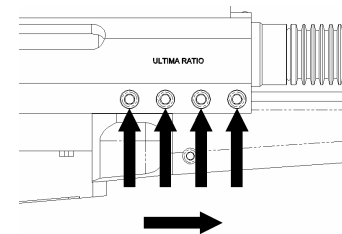

Removal of the barrel

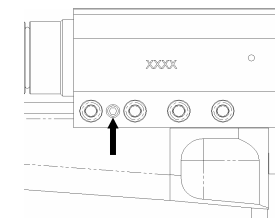

Opening receiver screw

- If necessary, move the receiver away from the barrel in tightening the opening receiver screw (maximum 2 turns) with a 3 mm hexagonal spanner.
- Carefully take the barrel out of the receiver.

### 6.7.2 Reinstallation of the barrel

- ☞ Ensure that the contact surfaces are perfectly clean.
- Loosen the opening receiver screw (2 turns).
- Push the barrel into the receiver.
- Introduce the bolt and close it.
- Tighten the 4 screws in starting from the rear and apply a torque of **10 N.m**.
- Tighten the opening receiver screw up to being in contact with spring. Then make 1 turn.

## 6.8 Muzzle brake and silencer

- ☞ **The muzzle brake can be removed only on commando 1 and 2 barrels which have the muzzle brake screwed.**
- ☞ In order to preserve an optimal shooting comfort, avoid firing without muzzle brake or silencer.

### 6.8.1 Installation of the muzzle brake

- Turn the muzzle brake clockwise by hand until it stops.
- Loosen it (maximum 1 turn) and make it level.
- Tighten the 2 screws with a 3 mm hexagonal spanner.

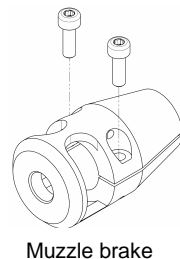

### 6.8.2 Installation of the silencer

- Remove the muzzle brake.
- Turn the silencer clockwise by hand until it stops.

- Tighten the 2 screws with a 3 mm hexagonal spanner.

- ☞ The chicanes and the spacers are tightened (by hand but strongly) by the front stopper. They should not move.
- ☞ Don't loosen the stopper located at the rear of the silencer.
- ☞ For cleaning it, only loosen the front stopper and remove the chicanes and the spacers.

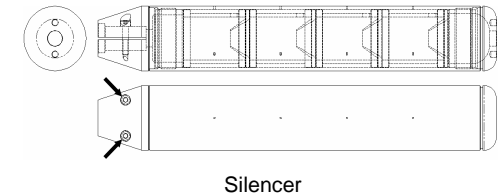

### 6.8.3 Silenced Barrel

- ☞ The silencer must be tightened (by hand but strongly) against the barrel insert.
- ☞ The chicanes and the spacers are pressed by the knurled stopper. They should not move.
- ☞ Don't remove the rear part of the silencer.
- ☞ For cleaning it, only loosen the rear stopper and remove the chicanes and the spacers.

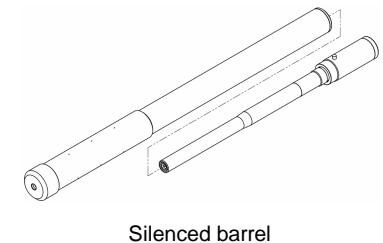

## 6.9 Scope mounts for picatinny rail

### 6.9.1 Installation

- ☞ Ensure the 2 jaws are free and right oriented (catch downwards).

- Put the mount at the desired position and push it against a sleeper.
- Using a 4 mm hexagonal spanner, tighten the 2 screws at torque of **6 N.m**.

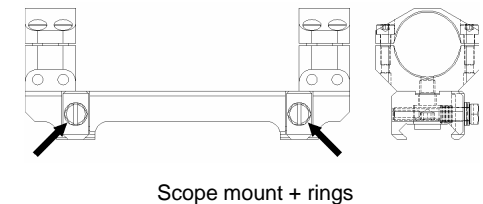

### 6.9.2 Scope slings

- Tighten the 8 M4 screws at torque of **4 N.m.**

### 6.10 Transport case

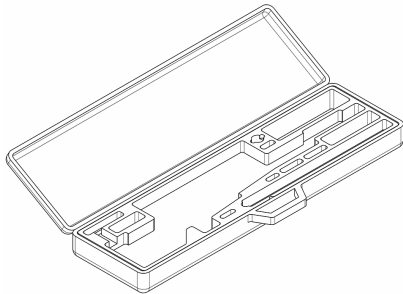

Case for all versions

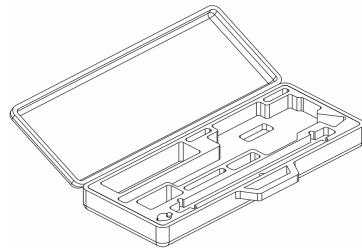

Case for version with folding buttstock\*

\* except version with silenced barrel

The transport case contains the following items :

- a rifle with a scope and a magazine
- the bolt
- 1 spare barrel (all versions)
- 2 spare magazines
- 1 silencer
- 1 sight
- the collective unit



Pelican Case 1700 / 1750

## 7. MAINTENANCE

- ☞ **Remove the bolt and ensure that the rifle is fully unloaded.**

### 7.1 Breaking in a new barrel

- ☞ To obtain an optimal precision, we advise you to break in a new barrel. It's not absolutely required but highly recommended.

- Clean the barrel with a cleaning wick.
- Fire a first round and clean the barrel with a bronze bore brush and then with a cleaning wick.
- Repeat the previous step at least 10 times.
- Fire 10 series of 3 rounds and after each series, clean the barrel with a bronze brush and then with a cleaning wick.
- Finally, fire 10 series of 5 rounds and after each series, clean the barrel with a bronze brush and then with a cleaning wick.

- ☞ Let cool the barrel after each series

### 7.2 Dismounting the weapon

- ☞ The full dismounting of the weapon must only be realised by an armorer or by PGM PRECISION.

- ☞ Before dismounting :
  - Unload the weapon.
  - Remove the magazine and the bolt.
  - Remove the scope.

### 7.2.1 Replacement of the extractor

- Using a 1.5 mm hexagonal spanner through the central hole of the extractor (1), push the plunger (2) just enough inwards so that it no longer holds the extractor in position.
- Take the plunger and the spring (3) out of their housing in the bolt.
- To reassemble, follow the above steps in reverse order.
- Lubricate them before installation.
- Ensure that the plunger correct engages the central hole of the extractor,
- Operate the extractor and lubricate.
- Using the extractor gauge, check the extractor overtaking.

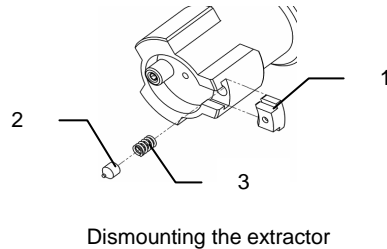

### 7.2.2 Replacement of the ejector

- Using a 1.5 mm hexagonal spanner, loosen the screw (1).
  - Push the ejector (2). Using a pair of pliers, withdraw the cylindrical pin (3) which secures the ejector.
  - Take the ejector and its spring (4) out of the bolt.
  - Clean and lubricate the hole.
  - To reassemble, follow the above steps in reverse order.
  - Lubricate and operate the ejector.
- ☞ Position the flat of the pin towards the screw.
- ☞ After its reinstallation, the cylindrical pin should slightly protrude from the ejector and not at all from the bolt.
- ☞ Stick the screw with low strength locking.

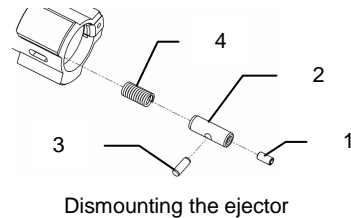

### 7.2.3 Replacement of the firing pin

- Remove the firing pin assembly from the bolt by turning the releasing tool about ¼ turn clockwise until it gets free of its locking cam.
  - Using the 3 mm hexagonal spanner, loosen the screw (1).
  - Remove the firing pin (2) and its spring (3).
  - Put the new firing pin and the new spring into the bolt.
  - Position the firing pin extension (4) in the bolt so that the firing pin extension key (5) is aligned with the groove of the bolt.
  - Position the key so that there is full contact between the rounded part of the key and the bottom of the notch in the body of the bolt.
  - Position part (6) and tighten the screw.
  - Lubricate and operate.
  - Using the firing pin gauge, check the firing pin overtaking.
- ☞ Stick the screw with low strength locking.

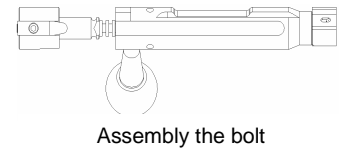
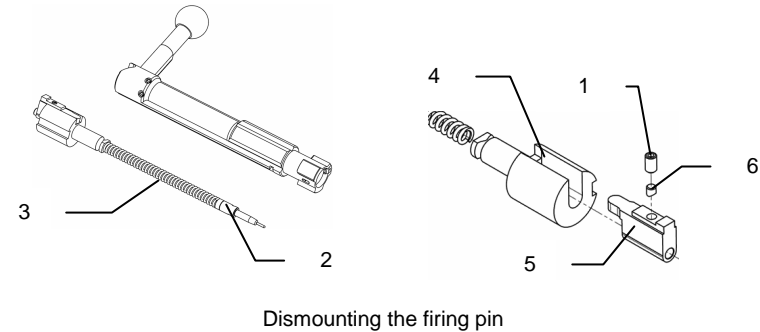

### 7.3 **Cleaning and lubrication**

- ☞ The respect of the indications hereafter will enhance the longevity and the performance of your rifle.
- ☞ Use the better oil which cleans, protect and lubricate your rifle.
- ☞ Please note that your weapon needs a regular maintenance and address you to a qualified armorer or directly to PGM PRECISION.

#### 7.3.1 **Cleaning and lubrication before firing**

- Clean the barrel with a cleaning wick.
- Ensure that the barrel is perfectly dry.
- Lubricate the bolt, the ejector and the extractor.

#### 7.3.2 **Cleaning and lubrication after firing**

- Start cleaning by complete strokes with the bronze bore brush soaked in oil.
- Wipe it with a cleaning wick until the last remains clean.
- Lubricate the barrel with a soaked cleaning wick.
- Clean the interior of the bolt.
- Lubricate the bolt.
- With a rag soaked in oil, wipe the exterior of the weapon and the moving parts.
- Lubricate the legs of the bipod.
- Dismantle the magazine and wipe it with a rag soaked in oil.
- Completely loosen the butt spike. Wipe and lubricate it.
- If it has been used, dismount the silencer and clean the chicanes and the spacers. Do not oil them, as they are made of stainless steel.
- Store the weapon in a dry and temperate room.

#### - **Caution :**

- ☞ Always clean the barrel from the bore to the muzzle.
- ☞ Use a bore guide.
- ☞ Never use a steel brush or abrasive materials.
- ☞ Only use spare parts coming from PGM PRECISION.

#### - **At least once a year :**

Your weapon has to be controlled by a qualified armorer or directly by PGM PRECISION.

© PGM Precision 2010